

FIRST-DAY

B. de NEMETHY'S TRAINING 1991

MATERIAL:
STANDARD: 30
POLES: 23
ALL HEIGHTS: 0.90M

SPREAD 1.50

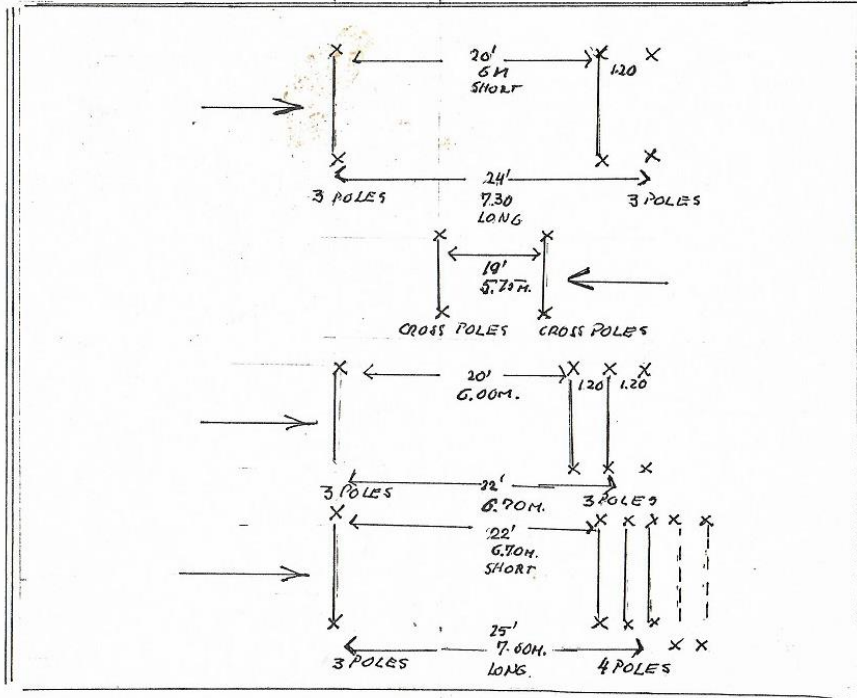

B. de NEMETHY'S CLINIC

FIRST DAY
X = 18 STANDARDS
11 POLES
4 POLES FOR CAU.

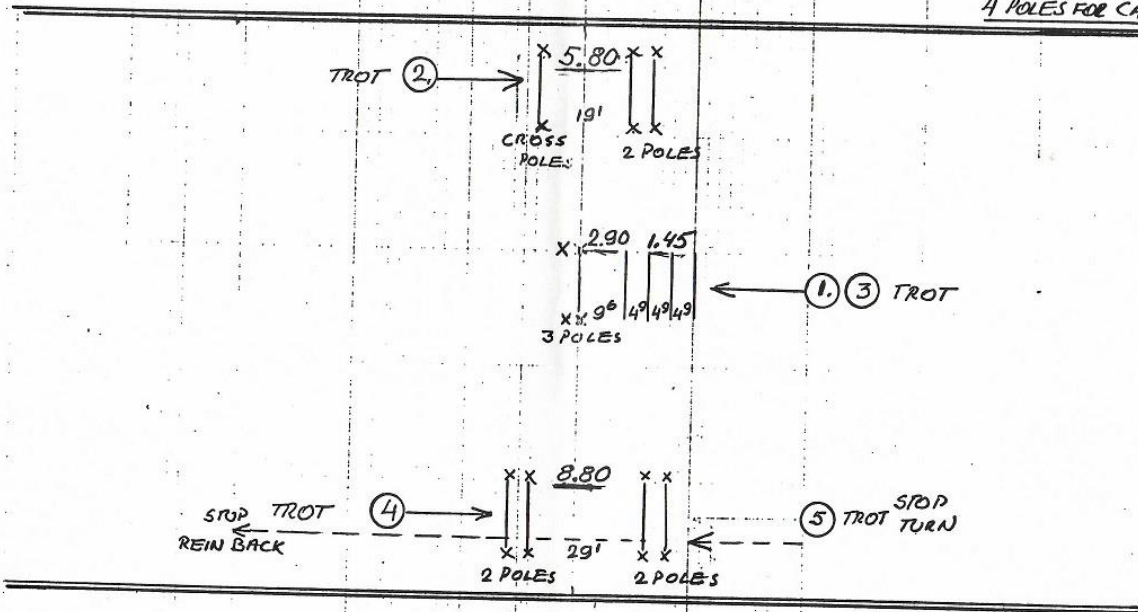

SECOND DAY

B. de NEMETHY'S TRAINING

MATERIAL
STANDARDS: 34
POLES: 22

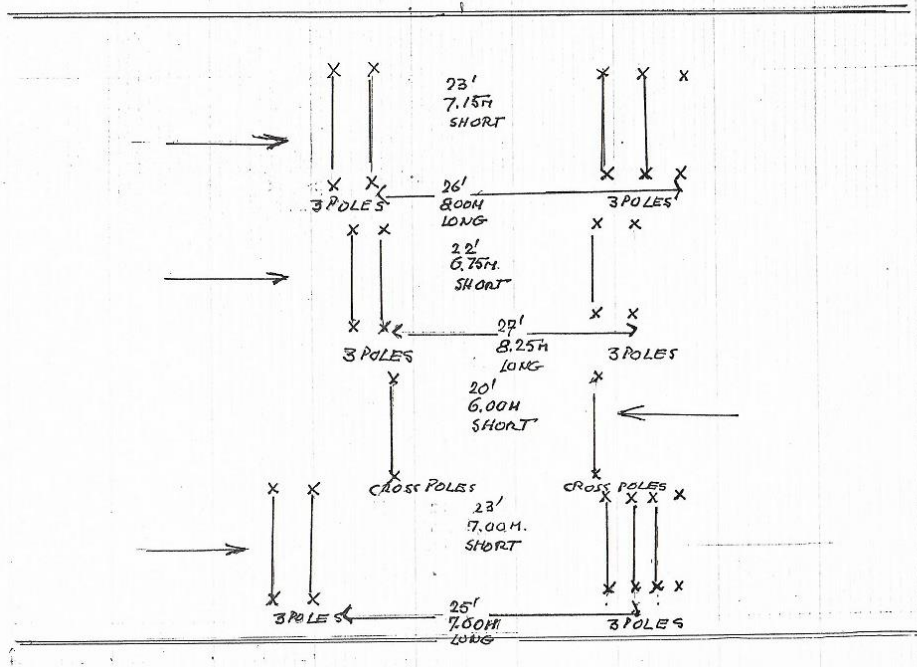

B. de NEMETHY'S CLINIC

SECOND DAY
X = 26 STANDARDS
15 POLES
4 POLES FOR CAU.

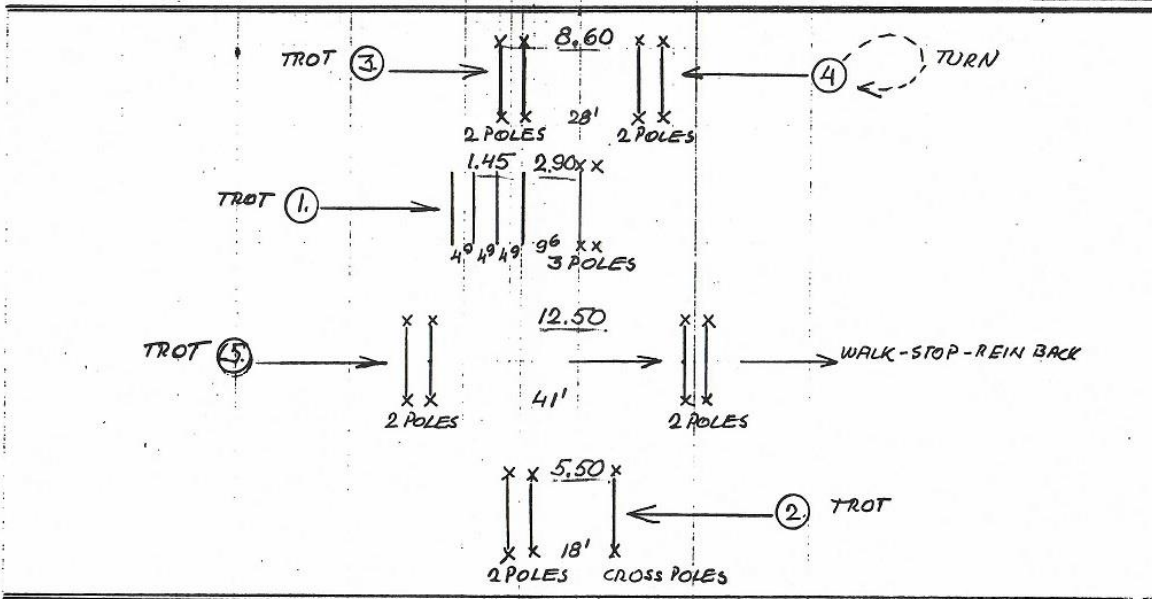

THIRD - DAY

B. de NEMETHY'S TRAINING.

MATERIAL
STANDARDS: 38
POLES : 31

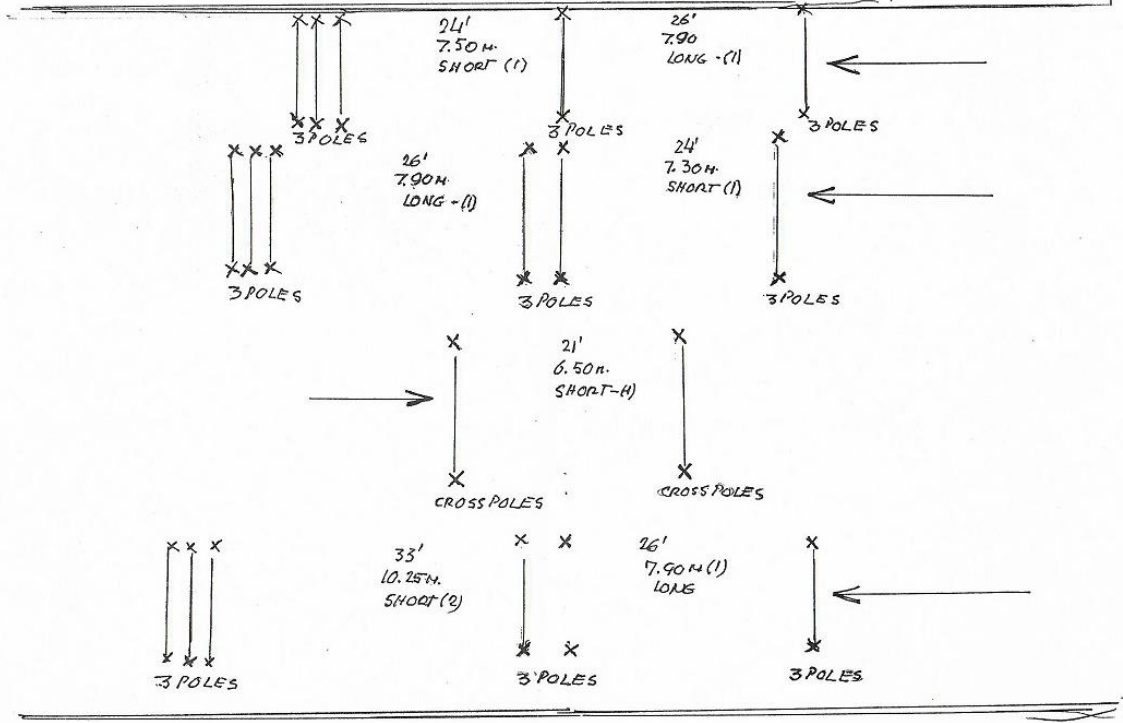

B. de NEMETHY CLINIC

THIRD DAY
 X = 34 STANDARDS
 20 POLES

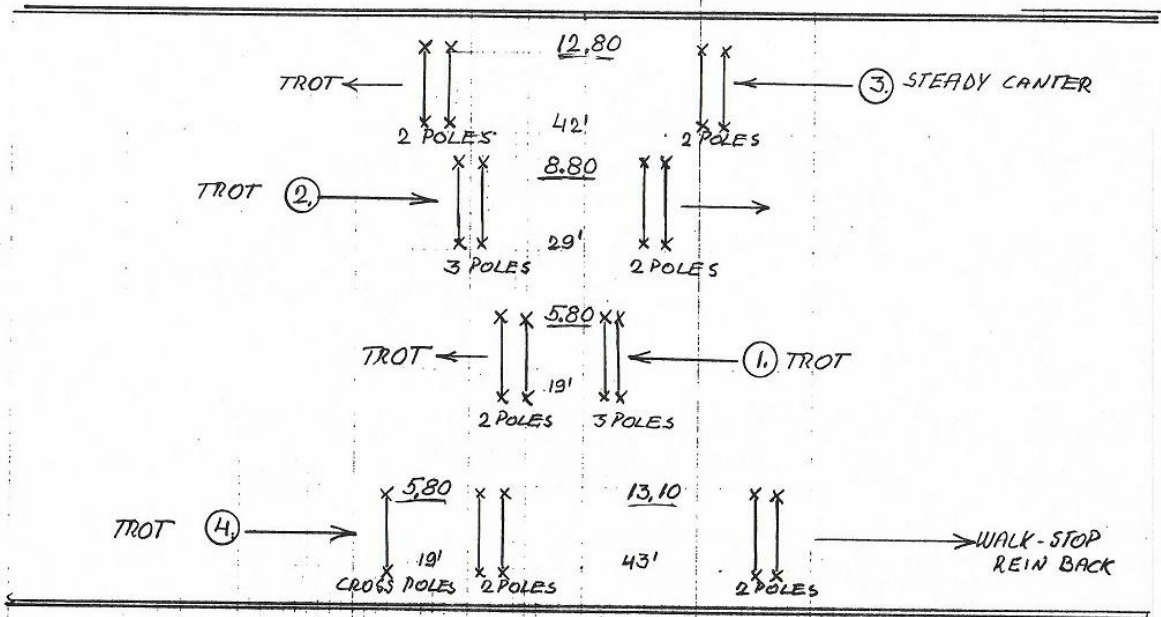

FORTH-DAY

B. de NEMETHY'S - TRAINING

MATERIAL
 STANDARDS: 40
 POLES: 31
 ALL HEIGHTS 1.00M
 ALL SPREADS 1.20
 TRIPLE BARS: 1.50M

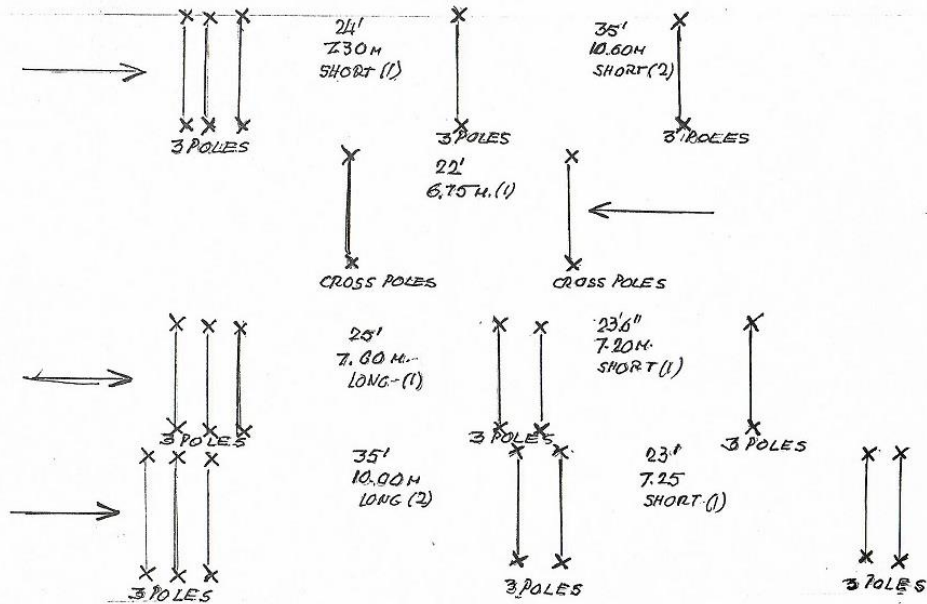

FIFTH-DAY

B. de NEMETHY - TRAINING

MATERIAL
 STANDARDS: 36
 POLES: 34
 ALL HEIGHT 1.00M.
 ALL SPREADS: 1.40M.

